

LEDBox 4xBasic102 650x160 - flag mount

TECHNICAL FEATURES



Description

650x160 LEDBox with 4 Basic 102 projectors.

OPTICAL FEATURES

Certification	EN12352: L2H
Light source	4xBasic102
Optic	Double-sided
Colour	Amber
Optical Group Life	> 50'000 Hours

ELECTRICAL FEATURES

Power supply	12 Vdc
Power consumption	4.2 W @ 12 Vdc (each projector)
Functioning	External command (Steady light)
Protections	Reverse polarity; Overvoltages
Insulation class	Class III

MECHANICAL FEATURES

Operating temperature	-25 °C ÷ +55 °C		
IP protection degree	IP67		
Dimensions	650 x 160 x 62 mm (brackets not included)		
Weight	3 Kg		
Fixing	60 mm	90 mm	Band-it

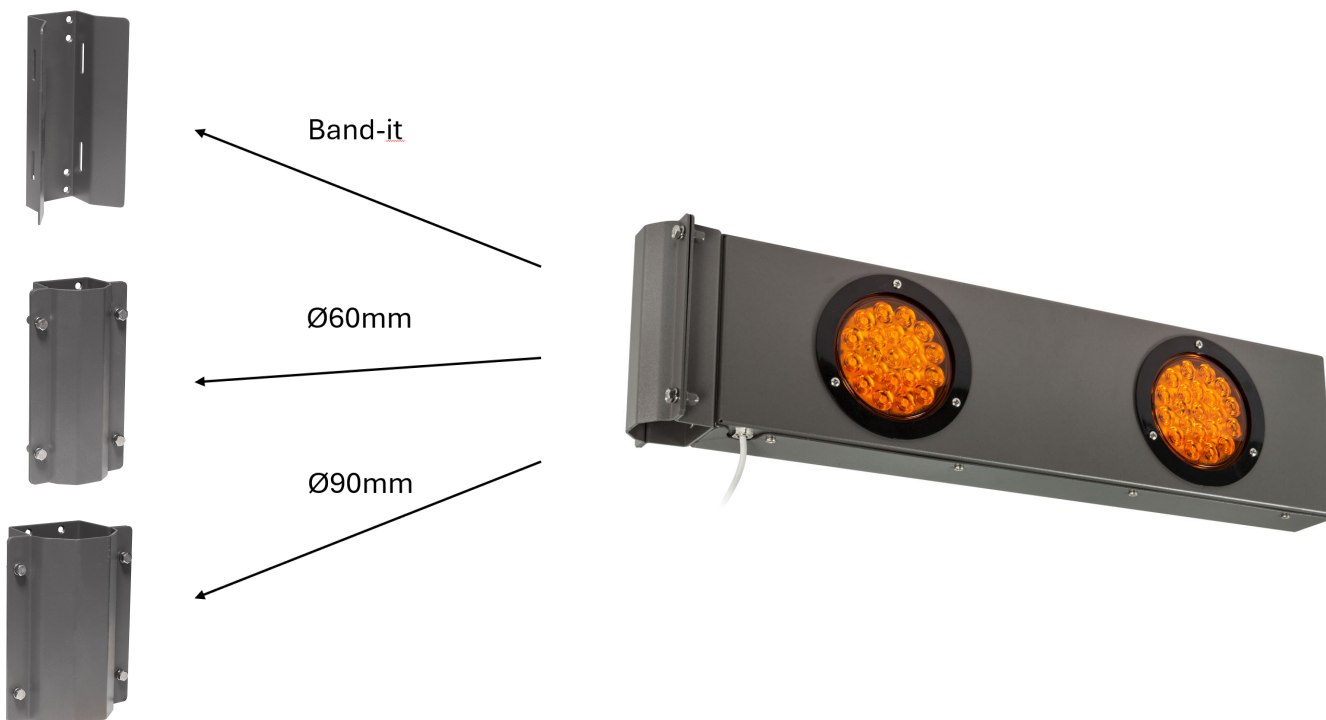

Rev. 3.0 20/05/2024		Approved TEC		Approved AQ
------------------------	--	--------------	--	-------------

Version with 60 mm pole brackets

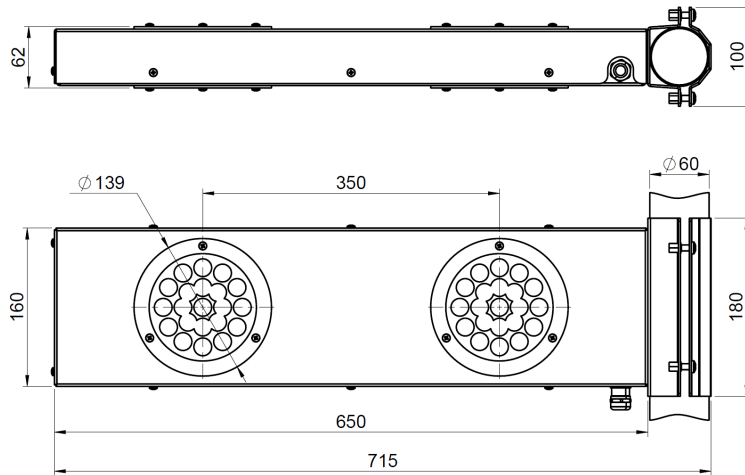

Version with 90 mm pole brackets

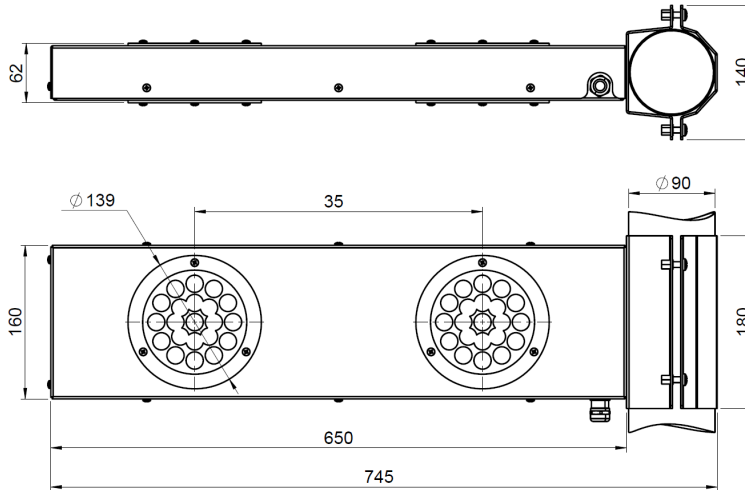

Version with Band-it pole brackets

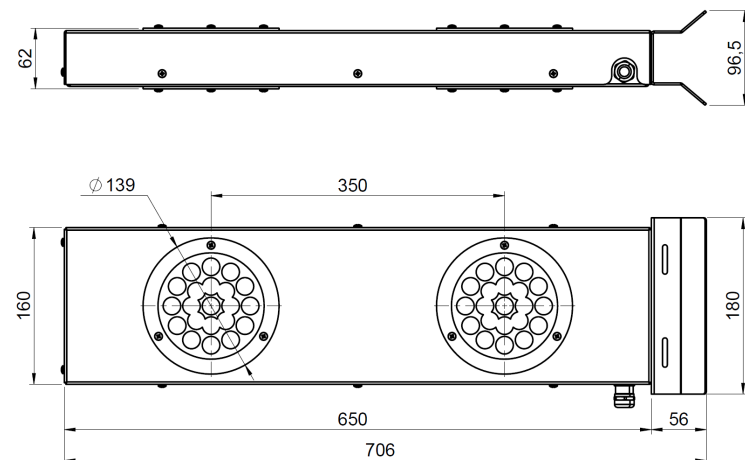

Rev. 3.0
20/05/2024

Approved TEC

Approved AQ