

## Istruzioni sequenziali con comandi esterni

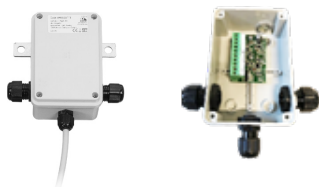

Comandi esterni Basic 200  
Basic 302 -LEDBOX



BOX113-BOX114-BOX118



BOX137

2- Collegare un BOX113 per ogni comando esterno;

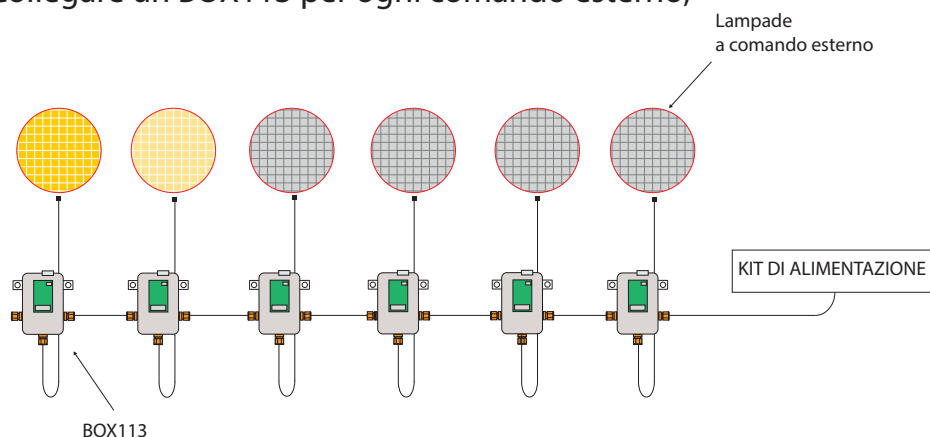

3- Collegare comandi esterni su L1 (+,-). Cablare i cavi come da figura (A) all'interno dei BOX113.

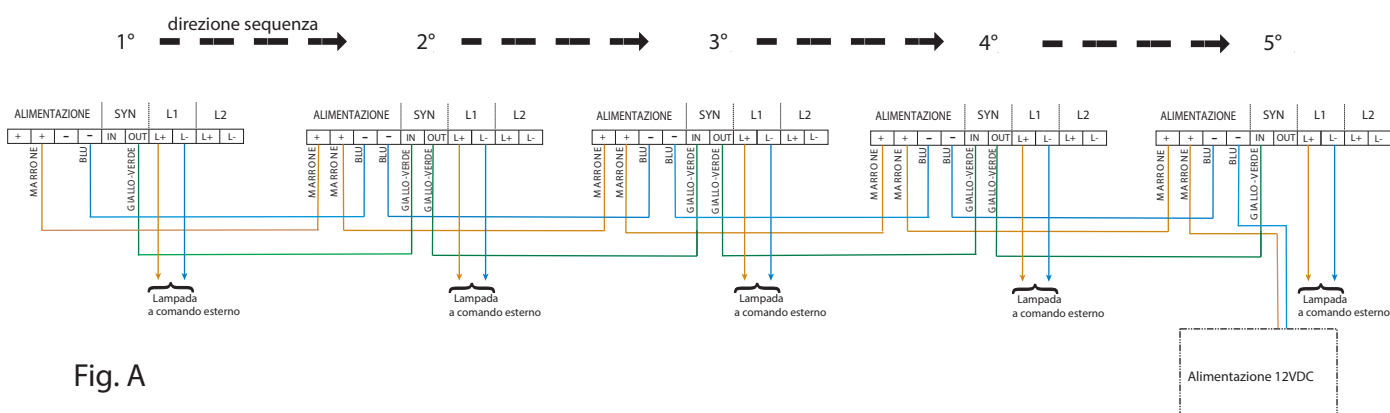
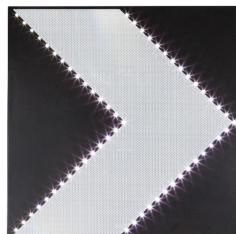

Fig. A

## Istruzioni sequenziali



Basic 200 - Basic 302  
con scheda per sequenza CE011



VISUAL LED



BOX137

2- Aprire la lampada o il BOX sul retro del Visual LED;

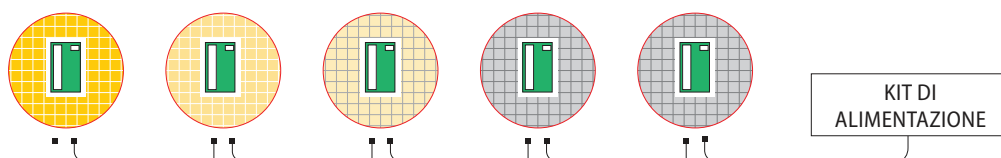

3- Cablare i cavi come da figura (B) all'interno delle lampade o del BOX sul retro del VISUAL LED

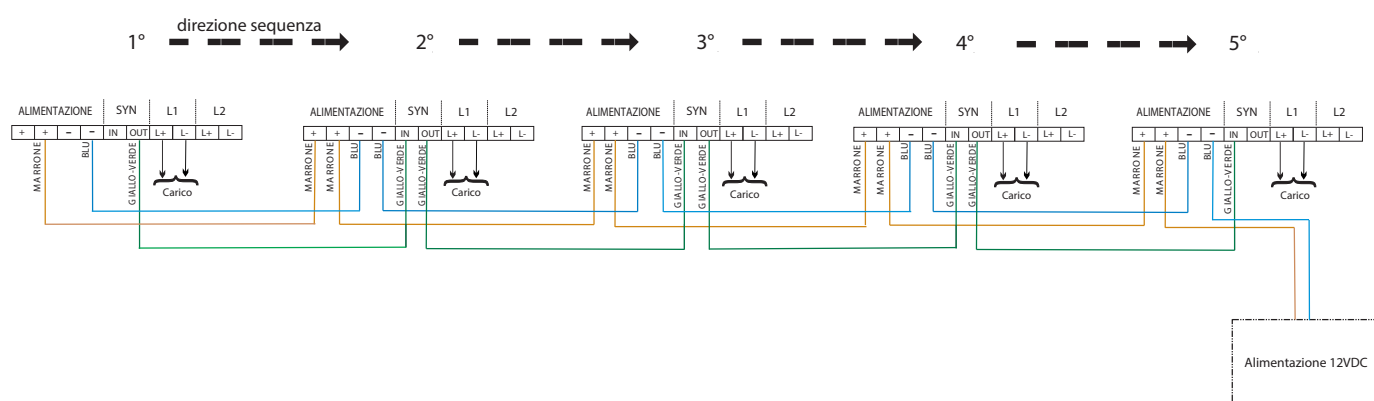

Fig. B

## Istruzioni sequenziali

Il kit di alimentazione può essere posizionato all'inizio (D) o alla fine della sequenza (E)

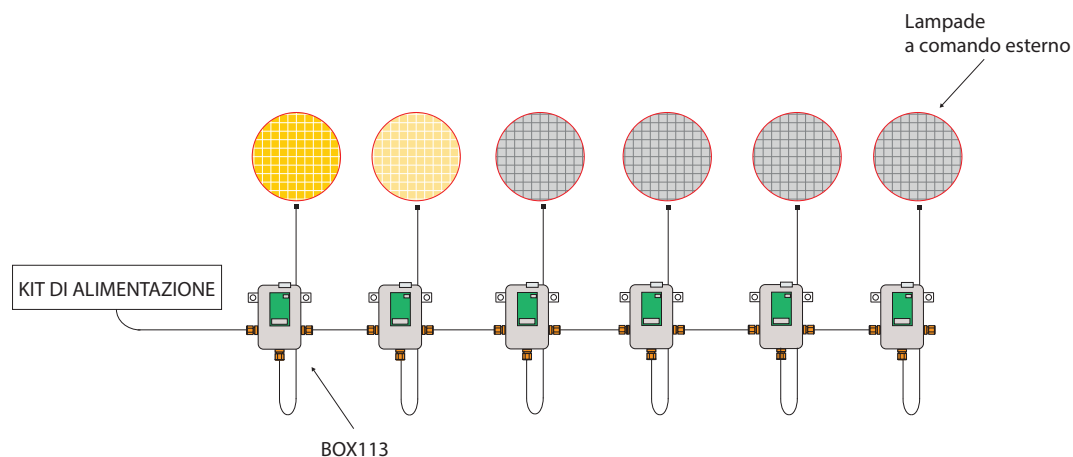

Fig. D

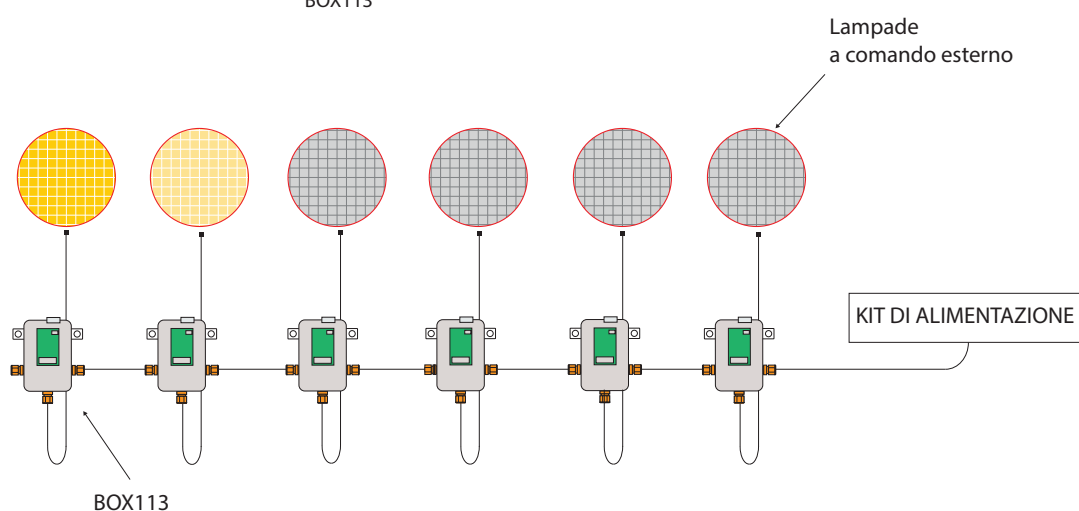

Fig. E

In caso di più punti di alimentazione o di alimentazione centrale, utilizzare un BOX 137 in corrispondenza del punto di alimentazione (F);

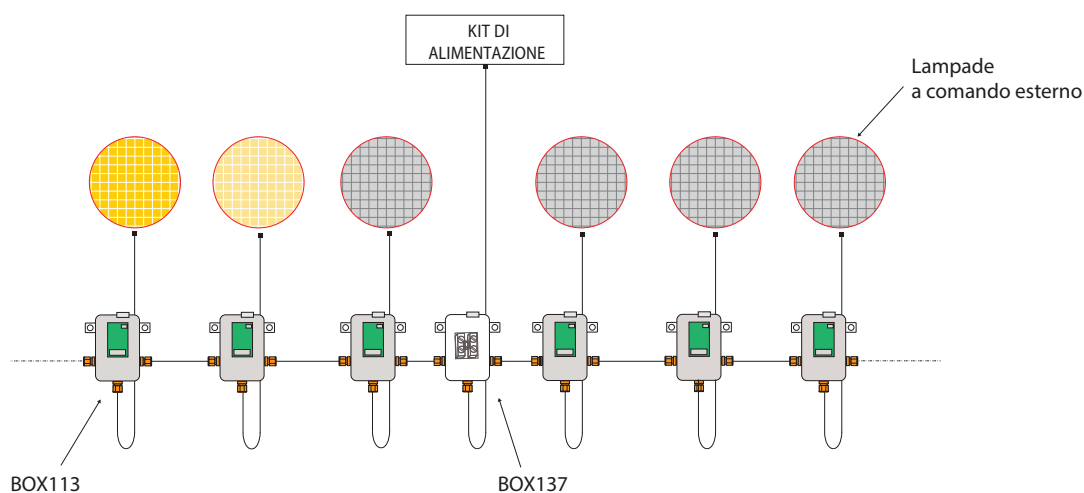

Fig. F